

# Infinite Position Recliner

---

628-52



Furniture that makes a difference.

## Product Description

### Straight back infinite position recliner

628S-52

**Style:** Suspend

**Model:** 628s-52

**Mechanism:** Sleeper recliner with reverse recline

**Operation:** Independent footrest and back recline with pedal operated reverse recline

### Flare back infinite position recliner

628F-52

**Style:** Suspend

**Model:** 628f-52

**Mechanism:** Sleeper recliner with reverse recline

**Operation:** Independent footrest and back recline with pedal operated reverse recline

## Dimensions

W	D	H	SW	SD	SH	RD	AH	COM	WT Cap
35"	37.5"	46"	24"	21"	20.5"	72"	26.75"	7 yds	550 lbs

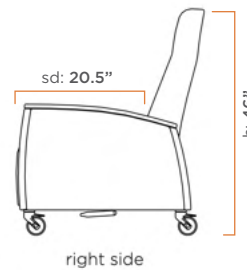
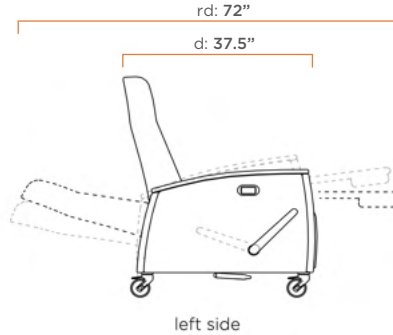
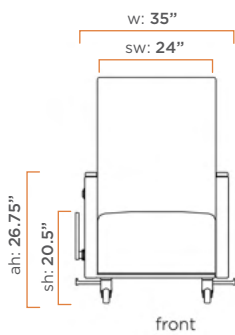

## Design Features

- Workhorse recliner built to withstand the rigors of 24/7 care
- Independent back and footrest allows for infinite reclining positions
- Available with multiple caster options for mobility and patient transport
- Intuitive Trendelenburg pedal
- Field replaceable components
- 550 lb Weight Capacity and optional Fall Prevention Technology

## Performance & Environmental Sustainability

- 550 lb capacity
- HHI Compliant
- 12 Year Warranty
- Air Quality Certification BIFMA

## Options

- 4628F** Flare back
- 4628PEA** Polyester arm caps / Specify color
- 4628SSA** Solid surface arm caps / Artic White
- 4628AHB** Adjustable head bolster / Straight back style

## Accessories

- |   |   |
|---|---|
| <b>4000DBH</b> Drainage bag hook-up / set of two                | <b>4000IPC</b> iPad Cradle  |
| <b>4000XTH</b> Oxygen tank holder                               | <b>4000SPT2</b> BKH Swivel Profile Tablet / 14x19 Thermofoil Top      |
| <b>4000XMB1</b> Seat moisture barrier                           | <b>4000SPT2X</b> BKH swivel profile tablet / 15 x 21.5 thermofoil top |
| <b>4000PBS</b> Soft grip push bar                               | <b>4000FST</b> Folding side tablet / 10x13 thermofoil top             |
| <b>4000IVP</b> IV Pole & holder                                 | <b>4000FSTX</b> Folding side tablet / 10x17 thermofoil top            |
| <b>4000IVH</b> IV Pole holder only                              | <b>4000SWT</b> Swiveling side tablet / 10x13 thermofoil top           |
| <b>4000CTB1</b> Cal 133 flammability                            | <b>4000SWTX</b> Swiveling side tablet / 10x17 thermofoil top          |
| <b>4000PRD</b> Paper roll dispenser / attached to back of chair | <b>4000POP</b> One 3-prong outlet / no USB                            |
| <b>4000FRG</b> Footrest guards / black plastic                  | <b>4000USB-P</b> Two USB ports - round plug with power cord           |
| <b>4000FAR</b> Folding Arm                                      | <b>4000PCS61A</b> One 3-prong outlet & 2 USB ports with power cord    |
| <b>4000RFT</b> Rolling foot tray                                | <b>4000HG-GD</b> One 3-prong outlet & 1 USB ports with power cord     |
| <b>4000ETV</b> Ergotron TV arm / no wiring                      | <b>FPT</b> 300 lb Footrest (Fall Prevention Technology)               |
| <b>4000HSL-NM</b> Heated seat & lumbar                          |   |
| <b>4000HC-MSG</b> Heated seat & lumbar with massage             |   |

FINGER PULL



PAPERROLL OPTION



MULTIPE CASTER OPTIONS

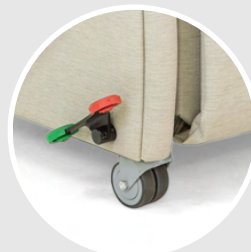

FOLDING ARM



# Materials

## Polyester

Armchairs / Footrest Lever

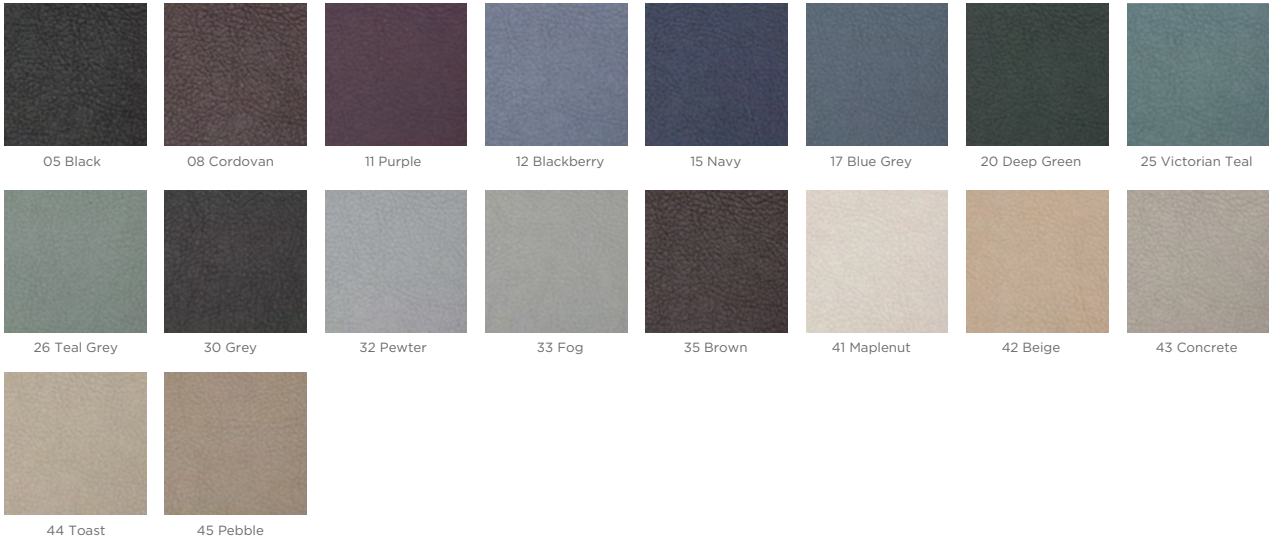

## Laminate

Tablets

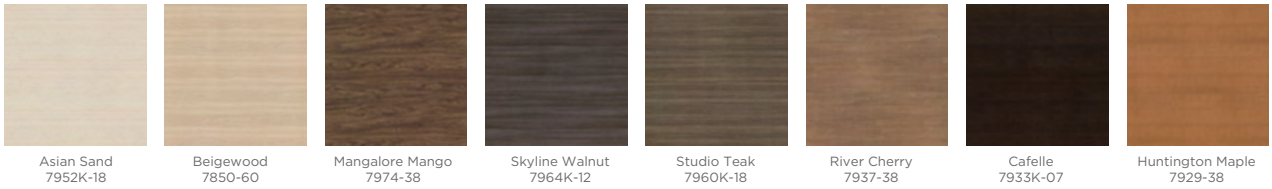

## Thermofoil

Tables

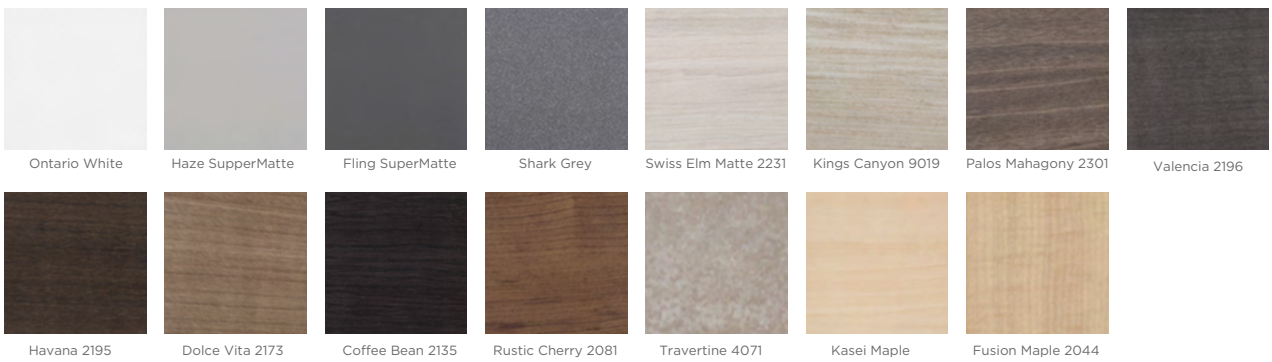

## LG Finishes

Tables

